

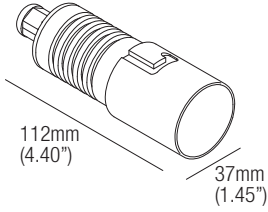

IP RATED DOWNLIGHTS

ZERUS 2

design: Roberto Mantovani



Supply current
Courant d'alimentation
Corriente de alimentación
500mA (V_i 2.9V)

Power
Puissance
Potencia
1.5W



FLEXALIGHTING

NORTH AMERICA

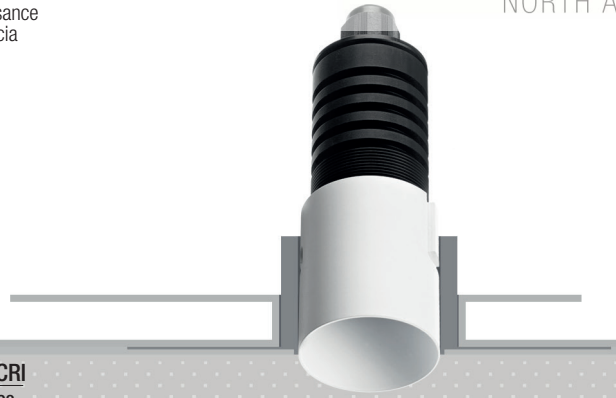

Photometric diagrams

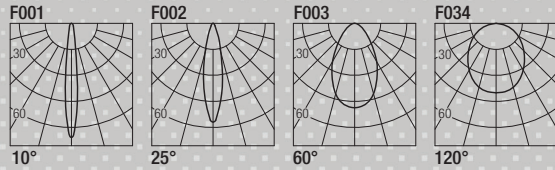

CCT	Flux	CRI
2700K	128 lm	93
3000K	133 lm	93
3500K	143 lm	93
4000K	154 lm	93

Code Construction

Construction du code produit
Construcción del código de producto

ZT1 | X | XX | X_i

ZT1	X	Beam angle	XX	Color Temp.	X	Finishing
		Angle de faisceau Ángulo del haz		Température couleur Temperatura de color		Finitions Acabados
	0	10°		27 2700K		B White Blanc Blanco
	1	25°		30 3000K		N Black Noir Negro
	2	60°		35 3500K		C Custom Personnalisée Personalizado
	9	120°		40 4000K		
				CU Custom Personnalisée Personalizado		

Drivers (Remote)

Alimentateurs
Alimentadores

Static White	Phase / 0-10V (Dual Dimming)	
500mA	CCPR010-A Min. 1 Max. 6	CCPR040-A Min. 1 Max. 18

Series wiring

Câblage en série
Cableado en serie

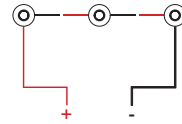

For other driver options - including Lutron, Dali and DMX - please consult factory

L001

Low luminance louvre
Filtre basse luminance
Filtro de baja luminancia



Note: the filter must be ordered together with the lighting fixture
Note: le filtre doit être commandé en même temps que l'appareil
Nota: el filtro debe pedirse junto con la luminaria

T-Bar Installation

R02050
Mounting Plate
with 40mm Hole

MP-R050
Mounting Plate
with 40mm Hole

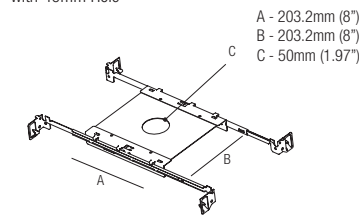
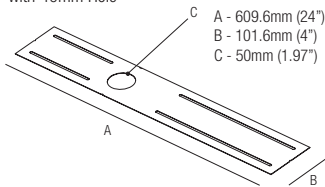

Accessories - Accessoires - Accesorios

ZQT00U

Plasterboard recessing frame
Boîtier d'encastrement pour plaques de plâtre
Cajetín para placas de yeso

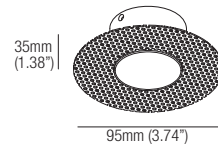

Hole Cut:
50mm
(1.97")

ZQT00U.BMK

Backmount frame
Pierre/bois montage arrière
Roca/madera montaje trasero

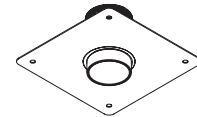

Hole Cut:
42mm
(1.65")

IC Housings

IC086R02050
Recessed Box for Insulated Ceiling with 50mm Hole

AT086R02050
Air Tight Recessed Box for Insulated Ceiling with 50mm Hole

