



IP RATED DOWNLIGHTS

TYRONE 6

design: Roberto Mantovani

Supply current
Courant d'alimentation
Corriente de alimentación

500mA (V_f 8.7V)

Power
Puissance
Potencia

4.5W

FLEXALIGHTING

NORTH AMERICA

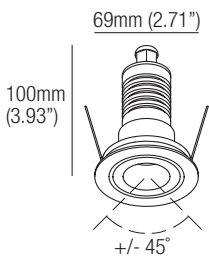

Photometric diagrams

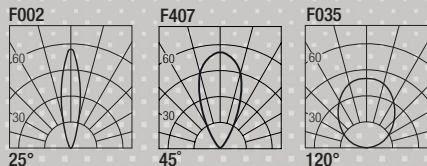

CCT	Flux	CRI	CCT	Flux	CRI
2400K	472 lm	95+	Dim to Warm	416 lm	90
2700K	421 lm	98+	1800K-3000K		
3000K	446 lm	98+			
3500K	464 lm	98+			
4000K	482 lm	98+			

Code Construction

Construction du code produit
Construcción del código de producto

TY|X|X|XX|X|E|

TR6	X	Beam angle	XX	Color Temp.	X	Finishing	E
		Angle de faisceau Ángulo del haz		Température couleur Temperatura de color		Finitions Acabados	
	1	25°		24		B	
	2	45°		27		N	
	9	120°		30		K	
				35		Z	
				40		C	
				DW			
				CU			

Drivers (Remote)

Alimentateurs
Alimentadores

Series wiring

Câblage en série
Cableado en serie

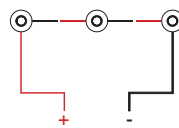

For other driver options - including Lutron, Dali and DMX - please consult factory

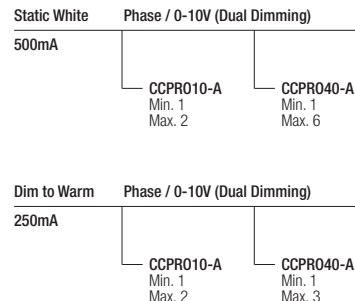

L001

Low luminance louvre
Filtre basse luminance
Filtro de baja luminancia



Note: the filter must be ordered together with the lighting fixture
Note: le filtre doit être commandé en même temps que l'appareil
Nota: el filtro debe pedirse junto con la luminaria

MP-R060
Mounting Plate
with 60mm Hole

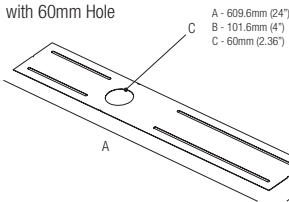

T-Bar Installation
R02060
Mounting Plate
with 60mm Hole

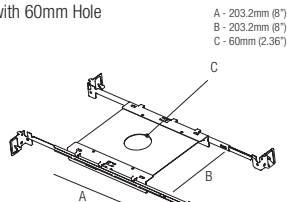

IC Housings

IC086R02060
Recessed Box for Insulated Ceiling with 60mm Hole

AT086R02060
Air Tight Recessed Box for Insulated Ceiling with 60mm Hole

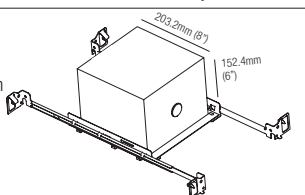

Optionals Accessoires Accesorios

CSXJ01

Recessing box
Boîtier d'encastrement
Caja de empotrar

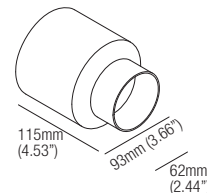

DCVI.B.1

24VDC Constant Voltage to Constant Current Converter
0-10V / Phase / Dim to Warm
Compatible, 13W

