

LAD R10

design: Roberto Mantovani

Supply current
Courant d'alimentation
Corriente de alimentación

Power
Pouissance
Potencia

500mA (V_I 18V)

10W

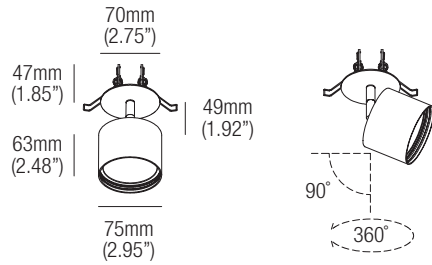

Photometric diagrams

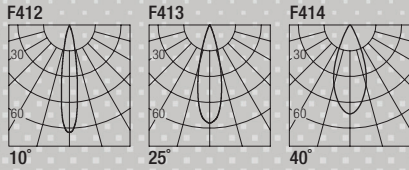

CCT	Flux	CRI
2400K	837 lm	95+
2700K	921 lm	98+
3000K	977 lm	98+
3500K	1016 lm	98+
4000K	1055 lm	98+

CCT	Flux	CRI
Dim to Warm 1800K-3000K	725 lm	95

Code Construction

Construction du code produit
Construcción del código de producto

LADR1 | X | XX | X |

LADR1	X	XX	X
Finishing Finitions Acabados	Color Temp. Température couleur Temperatura de color	Beam angle Angle de faisceau Ángulo del haz	
1 White Blanc Blanco	24 2400K	1 10°	
5 Black Noir Negro	27 2700K	2 25°	
C Custom Personnalisée Personalizado	30 3000K	3 40°	
	35 3500K		
	40 4000K		
	DW Dim Warm		
	CU Custom Personnalisée Personalizado		

Drivers (Remote)

Alimentateurs
Alimentadores

Series wiring

Câblage en série
Cableado en serie

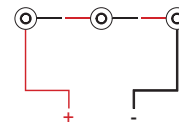

For other driver options -
including Lutron, Dali and DMX -
please consult factory

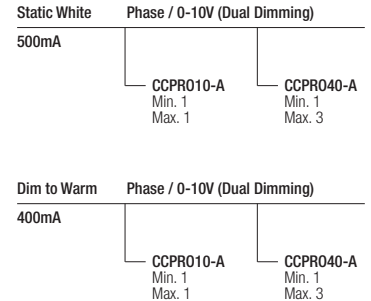

MP-R040
Mounting Plate
with 40mm Hole

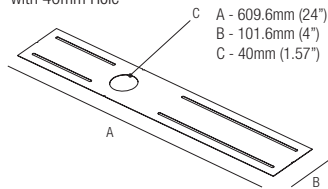

T-Bar Installation

RO1040
Mounting Plate
with 40mm Hole

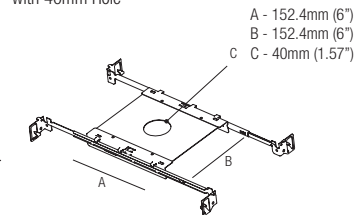

IC Housings

IC064R01040
Recessed Box for
Insulated Ceiling
with 40mm Hole

AT064R01040
Air Tight Recessed
Box for Insulated
Ceiling with
40mm Hole

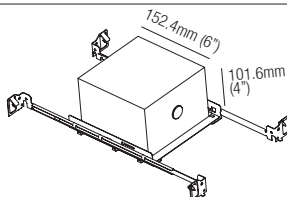

Optionals - Accessoires - Accesorios

LL01

Low luminance louvre
Filtre basse luminance
Filtro de baja luminancia



Note: the filter must be ordered
together with the lighting fixture
Note: le filtre doit être commandé en
même temps que l'appareil
Note: el filtro debe pedirse junto con
la luminaria

DCVI.B.1

24VDC Constant Voltage to
Constant Current Converter
0-10V / Phase / Dim to Warm
Compatible, 13W

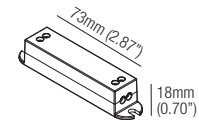

Note: versions with extended arm length are available upon request
Nota: versioni con lunghezza del braccetto maggiorata disponibili su richiesta
Note: versiones avec longueur du bras majorée disponibles sur demande