

ELIA R6

design: J. Allen

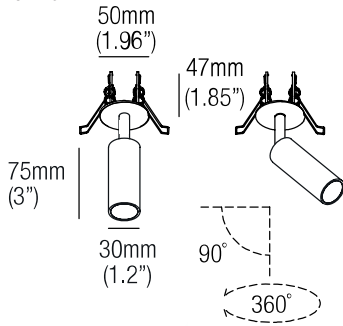

Supply current
Courant d'alimentation
Corriente de alimentación
500mA (V, 8.7V)

Power
Puissance
Potencia
4.5W



Photometric diagrams

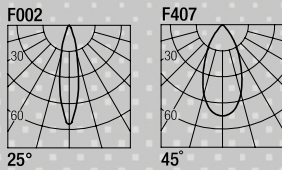

CCT	Flux	CRI
2400K	472 lm	95+
2700K	421 lm	98+
3000K	446 lm	98+
3500K	464 lm	98+
4000K	482 lm	98+
Dim to Warm 1800K-3000K	416 lm	90

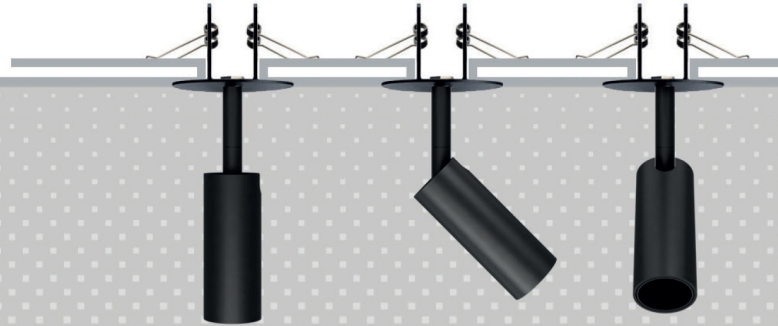

Code Construction

Construction du code produit
Construcción del código de producto

ELIR6 | X | X | XX |

ELIR6	X	Finishing Finitions Acabados	X	Beam angle Angle de faisceau Ángulo del haz	XX	Color Temp. Température couleur Temperatura de color
		1 White Blanc Blanco		S 25°		24 2400K
		5 Black Noir Negro		M 45°		27 2700K
		C Custom Personnalisée Personalizado				30 3000K
						35 3500K
						40 4000K
						DW Dim Warm
						CU Custom Personnalisée Personalizado

Drivers (Remote)

Alimentateurs
Alimentadores

Series wiring

Câblage en série
Cableado en serie

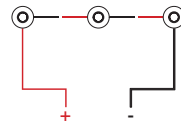

For other driver options -
including Lutron, Dali and DMX -
please consult factory

Static White	Phase / 0-10V (Dual Dimming)	
500mA	CCPR010-A Min. 1 Max. 2	CCPR040-A Min. 1 Max. 6
Dim to Warm	Phase / 0-10V (Dual Dimming)	
250mA	CCPR010-A Min. 1 Max. 2	CCPR040-A Min. 1 Max. 3

L001

Low luminance louvre

Filtere basse luminance
Filtro de baja luminancia



Note: the filter must be ordered together with the lighting fixture
Note: le filtre doit être commandé en même temps que l'appareil
Nota: el filtro debe pedirse junto con la luminaria

T-Bar Installation

R01040

Mounting Plate
with 40mm Hole

A - 152.4mm (6")
B - 152.4mm (6")
C - 40mm (1.57")

MP-R040
Mounting Plate
with 40mm Hole

A - 609.6mm (24")
B - 101.6mm (4")
C - 40mm (1.57")

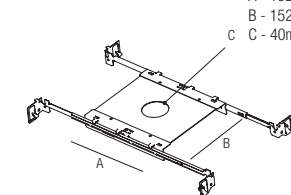
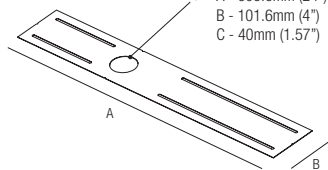

Optionals - Accessoires - Accesorios

DCVI.B.1

24VDC Constant Voltage to
Constant Current Converter
0-10V / Phase / Dim to Warm
Compatible, 13W

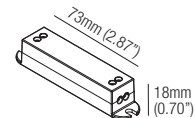

Note: versions with extended arm length are available upon request
Nota: versioni con lunghezza del braccetto maggiorata disponibili su richiesta
Note: versions avec longueur du bras majorée disponibles sur demande

IC Housings

IC064R01040

Recessed Box for
Insulated Ceiling
with 40mm Hole

AT064R01040

Air Tight Recessed
Box for Insulated
Ceiling with
40mm Hole

