

# BLACK 6

design: Lapo Grassellini

**Supply current**  
Courant d'alimentation  
Corriente de alimentación  
**500mA** (V<sub>i</sub> 8.7V)

**Power**  
Puissance  
Potencia  
**4.5W**

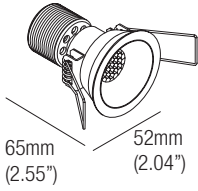

## Photometric diagrams

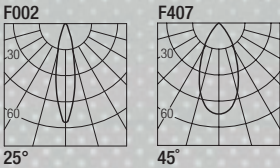

CCT	Flux	CRI	CCT	Flux	CRI
2400K	472 lm	95+	Dim to Warm	416 lm	90
2700K	421 lm	98+	1800K-3000K		
3000K	446 lm	98+			
3500K	464 lm	98+			
4000K	482 lm	98+			

## Code Construction

Construction du code produit  
Construcción del código de producto

**BK2 X XX X E**

<b>BK2</b>	<b>X</b>	<b>Finishing</b> Finitions Acabados	<b>XX</b>	<b>Color Temp.</b> Température couleur Temperatura de color	<b>X</b>	<b>Beam angle</b> Angle de faisceau Ángulo del haz
	<b>1</b>	White Blanc Blanco	<b>24</b>	2400K	<b>S</b>	25°
	<b>5</b>	Black Noir Negro	<b>27</b>	2700K	<b>M</b>	45°
	<b>C</b>	Custom Personnalisée Personalizado	<b>30</b>	3000K		
			<b>35</b>	3500K		
			<b>40</b>	4000K		
			<b>DW</b>	Dim Warm		
			<b>CU</b>	Custom Personnalisée Personalizado		

## Drivers (Remote)

Alimentateurs  
Alimentadores

## Series wiring

Câblage en série  
Cableado en serie

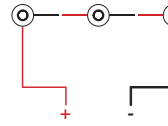

For other driver options - including Lutron, Dali and DMX - please consult factory

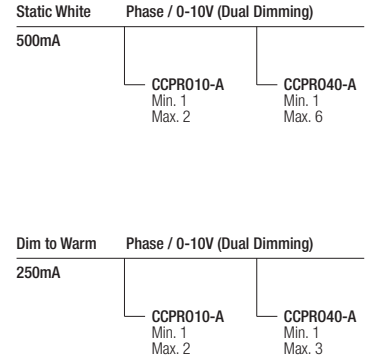

**MP-R045**  
Mounting Plate  
with 45mm Hole

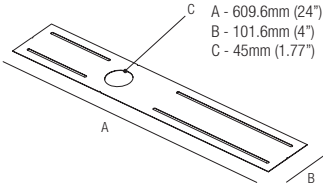

## T-Bar Installation

**R01045**  
Mounting Plate  
with 45mm Hole

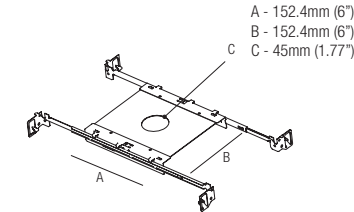

## IC Housings

**IC064R01045**  
Recessed Box for  
Insulated Ceiling  
with 45mm Hole

**AT064R01045**  
Air Tight Recessed  
Box for Insulated  
Ceiling with  
45mm Hole

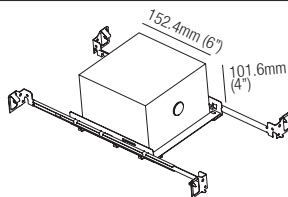

## Optionals - Accessoires - Accesorios

**DCVI.B.1**  
24VDC Constant Voltage to  
Constant Current Converter  
0-10V / Phase / Dim to Warm  
Compatible, 13W

