

# BABA R2

design: Roberto Mantovani

**Supply current**  
 Courant d'alimentation  
 Corriente de alimentación  
**500mA (V<sub>f</sub> 2.9V)**

**Power**  
 Pouissance  
 Potencia  
**1.5W**

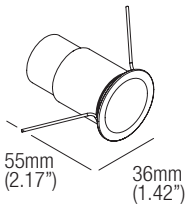

### Photometric diagrams

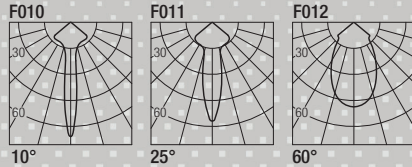

CCT	Flux	CRI
2700K	128 lm	93
3000K	133 lm	93
3500K	143 lm	93
4000K	154 lm	93

### Optionals

Accessoires  
 Accesorios

### CS1006

**Recessing box**  
 Boîtier d'encastrement  
 Caja de empotrar

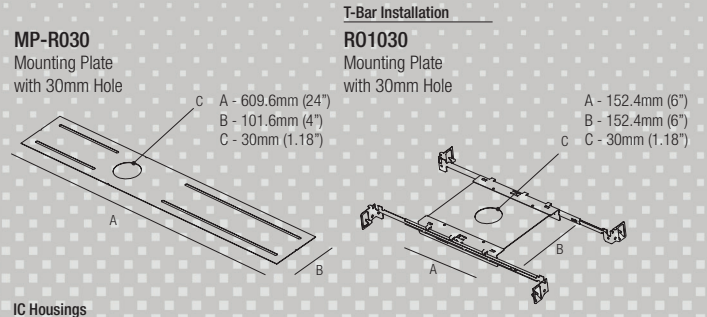
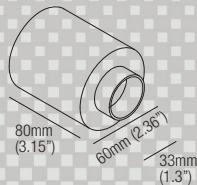

### IC Housings

**IC064R01030**  
 Recessed Box for  
 Insulated Ceiling  
 with 30mm Hole

**AT064R01030**  
 Air Tight Recessed  
 Box for Insulated  
 Ceiling with  
 30mm Hole

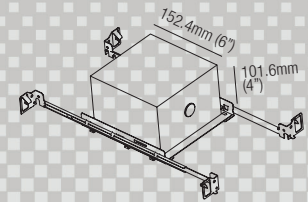

# BABA Q2

design: Roberto Mantovani

**Supply current**  
 Courant d'alimentation  
 Corriente de alimentación  
**500mA (V<sub>f</sub> 2.9V)**

**Power**  
 Pouissance  
 Potencia  
**1.5W**

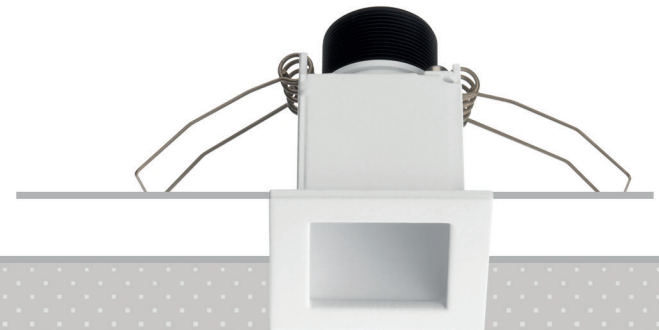
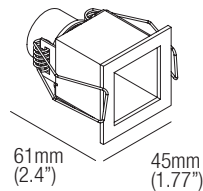

### Photometric diagrams

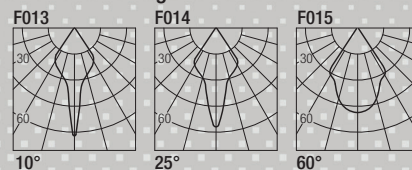

CCT	Flux	CRI
2700K	128 lm	93
3000K	133 lm	93
3500K	143 lm	93
4000K	154 lm	93

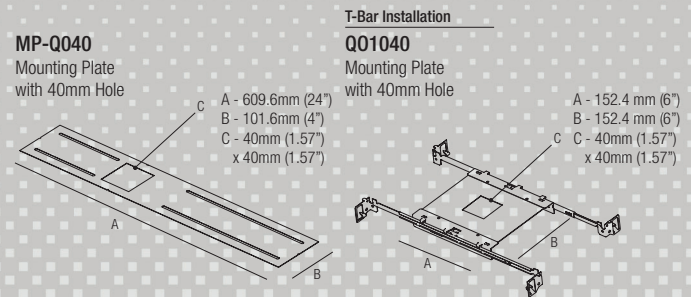

### IC Housings

**IC064Q01040**  
 Recessed Box for  
 Insulated Ceiling  
 with 40mm Hole

**AT064Q01040**  
 Air Tight Recessed  
 Box for Insulated  
 Ceiling with  
 40mm Hole

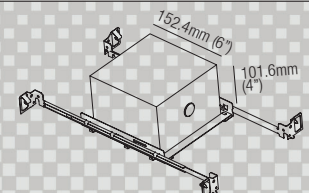



### Code Construction

Construction du code produit  
 Construcción del código de producto

BS|X|X|X|XX|

BS	X	Shape Forma Forme	X	Finishing Finitions Acabados	X	Beam angle Angle de faisceau Ángulo del haz	XX	Color Temp. Température couleur Temperatura de color
		<b>1</b> Round Rond Redondo		<b>1</b> White Blanc Blanco		<b>0</b> 10° <b>1</b> 25° <b>2</b> 60°		<b>27</b> 2700K <b>30</b> 3000K <b>35</b> 3500K <b>40</b> 4000K <b>CU</b> Custom Personnalisée Personalizado
		<b>2</b> Square Carré Cuadrado		<b>5</b> Black Noir Negro				
				<b>C</b> Custom Personnalisée Personalizado				

### Drivers (Remote)

Alimentateurs  
 Alimentadores

### Series wiring

Câblage en série  
 Cableado en serie

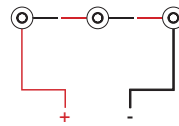

For other driver options -  
 including Lutron, Dali and DMX -  
 please consult factory

Static White	Phase / 0-10V (Dual Dimming)		
500mA	<table border="1"> <tr> <td>CCPRO10-A Min. 1 Max. 6</td> <td>CCPRO40-A Min. 1 Max. 18</td> </tr> </table>	CCPRO10-A Min. 1 Max. 6	CCPRO40-A Min. 1 Max. 18
CCPRO10-A Min. 1 Max. 6	CCPRO40-A Min. 1 Max. 18		