

DLM.60

Dimmable Constant Voltage LED Driver, Phase Dimming, ELV, Triac, 0-10V, 60W

IP20 Class 2

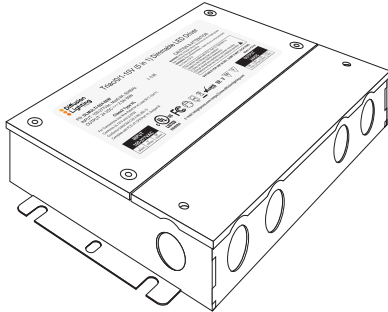

Features

- Protection from short circuits, over current and over voltage
- Internal self-reset mini breakers
- Compatible with virtually every style dimmer
- Flicker-free ~ 20,000 Hz
- Indoor/Outdoor
- High Efficiency
- Working Temp: -40° C to 80° C
- Wet location rated

Dimensions

Driver

165 mm (6.49 in) L x 95 mm (3.75 in) W x 26 mm (1.02 in) H

Knock Outs

Sides: 6 x 0.5 in (12 mm) Back: 2 x 0.85 in (21 mm)

NOTE: Standard 1/2" connectors won't fit.

Specifications

INPUT VOLTAGE	100-277 VAC
OUTPUT VOLTAGE	24 Volts DC
OUTPUT CURRENT	2.5 A
DIMMABLE	Yes
DIMMING RANGE	0-100%
WATTAGE	60W
ENVIRONMENT	Indoor and Outdoor
IP RATING	NEMA 4X
OPERATING TEMP	-40°C to 80°C

